



**Operation Guide  
Applies to Waterous Model**

**250-120-DSC  
Rev 1**

**Unit Serial Number** \_\_\_\_\_

Waterous, Arizona Operations  
7612 North 74th Ave.  
Glendale, Arizona 85303  
623-979-3398  
Fax: 623-979-6949  
[www.waterousco.com](http://www.waterousco.com)

## Warnings, Cautions, and Notes

---

**Warning** A warning alerts you to a procedure, practice or condition that may result in death or long term injury to personnel or destruction of equipment.

---



---

**Caution** A caution alerts you to a procedure or condition that may result in serious damage to equipment or its failure to operate as expected

---

**Note:** A note points out important information. Failure to read the note may not result in physical harm to personnel or equipment. It may waste time and money.

## Revision History

Revision	Date Issued	Comments
---	01/04	Original Release
1	11/27/06	Reformatted, new logo, added T/S Guides, Electrical / Manual Auto-sync ops,
	7/9/08	Updated Maintenance Items

**Disclaimer:** These instructions are guidelines only and in no way meant to be definitive. During installation, standard safety precautions and equipment should be used where appropriate. Because the tools used and the skill/experience of the installer can vary widely, it is impossible to anticipate all conditions under which this installation is made, or to provide cautions for all possible hazards. Proper installation is the responsibility of the purchaser. All bolts, setscrews, and belts must be checked prior to start-up AND after the initial operation. Damages due to poor installation are the responsibility of the installer.

# Table of Contents

SECTION 1. OPERATING INSTRUCTIONS .....	4
A. Multiple Uses .....	4
B. For Electric Auto-Sync .....	4
I. Water Pumping Operations .....	5
II. Foam Solution Operations .....	5
III. Compressed Air Foam Operations .....	6
IV. Compressed Air Only Operation .....	7
C. For Manual Auto-Sync .....	8
I. Water Pumping Operations .....	8
II. Foam Solution Operations .....	9
III. Compressed Air Foam Operations .....	9
IV. Compressed Air Only Operation .....	10
D. Shut-Down Procedure .....	11
SECTION 2. AIR COMPRESSOR .....	12
A. How It Works .....	12
SECTION 3. SYSTEM SERVICE AND MAINTENANCE .....	13
A. Maintenance Schedule .....	14
B. Maintenance Items .....	14
C. Wye Strainer for Cooler .....	15
SECTION 4. CAFS NOZZLE / FLOW RATE / HOSE COMBINATIONS .....	16
A. Nozzles .....	16
B. Foam Concentrate Ratios .....	16
C. Hose .....	16
SECTION 5. SUGGESTED GUIDELINES FOR THE PRODUCTION OF MID-RANGE COMPRESSED AIR FOAM .....	17
A. 1" (25 mm) Hose Diameter Jacketed .....	17
B. 1-1/2" (38 mm) Hose Diameter .....	17
C. 1-3/4" (44 mm) Hose Diameter .....	18
D. Master Stream .....	19
SECTION 6. TROUBLESHOOTING .....	20
A. CAFS .....	20
B. Pump .....	24
SECTION 7. DRAWINGS .....	28
SECTION 8. CONDITIONAL 5-YEAR WARRANTY POLICY .....	35

## Figure(s)

Figure 1 Electric Auto-sync panel .....	4
Figure 2 Manual Auto-sync panel .....	8
Figure 3 Wye Strainer .....	15
Figure 4 Wye-strainer installed, with cleanout valve .....	15
Figure 5 Clean Strainer .....	15
Figure 6 Dirty Strainer .....	15
Figure 7 Controls and Dimensions .....	28
Figure 8 Basic CAFS Schematic .....	29
Figure 9 Hydraulic Schematic .....	30
Figure 10 Air Schematic, Manual Auto-sync, 90° Inlet .....	31
Figure 11 Air Schematic, Manual Auto-sync, Vertical Inlet .....	32
Figure 12 Air Schematic, Electric Auto-sync, 90° Inlet .....	33
Figure 13 Air Schematic, Electric Auto-sync, Vertical Inlet .....	34

## SECTION 1. OPERATING INSTRUCTIONS

Check the following fluid levels daily or prior to starting unit:

- Engine oil
- Engine coolant
- Compressor system oil (oil level should be visible through the hole in the compressor oil access door).
- Onboard water supply

### A. Multiple Uses

The Waterous modular compressed air foam unit can be operated in several pumping modes; water only, foam solution without compressed air, compressed air foam and compressed air only for support operations such as operating air tools, filling rescue air bags, etc. It is possible to pump foam solution from one discharge while pumping compressed air foam from another, or varying foam consistencies (expansion ratios) from different discharges simultaneously.

**NOTE:** Monitor engine and compressor instruments during any and all operations.

### B. For Electric Auto-Sync



Figure 1 Electric Auto-sync panel

## I. Water Pumping Operations

All unit operations begin with pumping water. These steps must be followed for operations involving pumping water, foam solution, compressed air or compressed air foam.

1. Connect the hose(s) to the desired discharge(s).

---

**WARNING:** Prior to starting the engine, the Auto Sync controls should be in the UNLOAD position, which allows the air compressor to “free wheel” without pumping air.

---

2. If pumping water from an on board booster tank, fully open the tank to pump valve.
3. If pumping from an overboard source, the tank to pump valve should be fully closed.
4. If so equipped, turn on the main power switch to the CAFS unit.
5. Star the engine
6. Throttle-up to desired pressure.  
If pump pressure is absent, it will be necessary to prime the pump utilizing the Waterous Jet Primer. The Jet Primer utilizes compressed air from the onboard compressor system, which is passed through a venturi, creating a vacuum within the water pump.
  - To prime, move the Auto-Sync controls to the FIXED position to build air pressure.
  - Once air pressure has risen, move the Jet Primer to the open position. The rush of air through the priming venturi will be audible.
  - As water is drawn into the pump, some will be vented through the venturi and spill onto the ground. When the water discharge pressure gauge rises, the pump is primed.
  - After prime is achieved, close the Jet Primer. For water only operations, move the Auto-Sync controls back to the UNLOAD position.
7. Open desired discharge valve(s) and throttle-up to desired pressure.

---

**CAUTION:** Running the unit with a dry fire pump can cause damage to the pump and air compressor system.

---

## II. Foam Solution Operations

Follow the instructions above for water pumping operations.

Turn on the foam proportioner to inject foam concentrate into the water stream. Refer to the foam proportioner operation manual for instructions in the proper operation of the installed proportioning system.

### III. Compressed Air Foam Operations

Follow the instructions above for foam solution operations. Safe operations dictate the presence of foam concentrate in the water stream prior to the injection of compressed air. If foam concentrate is not present, a condition known as “slug flow” will occur. This is where unmixed water and air is discharged through a nozzle in an erratic manner.

1. Set water discharge pressure at the desired level. Discharge pressures for compressed air foam operations typically range between 80 and 120 PSI in a flow state.

**NOTE:** Compressed air foam does not have the hydraulic characteristics of plain water or foam solution. Therefore, standard pump hydraulics practices do not apply to CAFS operations.

2. Move Auto-Sync controls to the AUTO position.  
Air pressure as shown on the air pressure gauge should rise to within plus or minus 5% of the water discharge pressure. The Auto-Sync system will balance the air and water pressures throughout a range of 40 PSI up to 150 PSI. Optimal compressed air foam system performance occurs at discharge flow pressures of 80-120 PSI.
3. Set proportioner at 0.2% - 0.6% for normal Class A combustibles.  
The type and brand of foam concentrate used and the tactical objective, dictate proportioning rates.
4. Open desired discharge valve(s).  
Controlling the amount of foam solution entering the discharge stream sets the foam expansion ratio. High solution flows restrict the amount of air admitted and result in lower expansion or “wet” foam. To produce higher expansion or “drier” foam, simply gate back the amount of solution admitted.
5. Fully open the air valve(s) to the desired discharge(s).
6. Adjust the solution flow to produce the desired foam consistency.

Foam is formed during the transition through the hose. To produce acceptable finished foam, sufficient hose length must be provided on the discharge. Refer to the section “Suggested Guidelines for the Production of Mid-Range Compressed Air Foam”.

---

**WARNING:** Nozzle reaction force is significantly increased at the time the nozzle valve is opened in compressed air foam operations. **OPEN CAFS NOZZLES SLOWLY!**

---

## IV. Compressed Air Only Operation

Follow instructions for water pumping operations without opening discharge valves. Air compressor cooling is via water that is circulated by the fire pump through the compressor cooler and returned back to the booster tank. During this operation, time is limited by the amount of available cooling water.

The water in the booster tank will eventually become heat saturated and ineffective at cooling the air compressor. Watch the compressor temperature gauge closely! Maximum is 250°F. Compressor system overheat is also indicated by the panel mounted warning light and alarm.

1. After engine start, ensure that the water pressure as shown on the panel mounted gauge rises.
2. Move Auto-Sync control to the FIXED position. Air pressure will rise to the preset pressure setting on the air compressor, approximately 150-PSI with the engine throttled-up.
3. For lower operating pressures, move the Auto-Sync controls to the AUTO position and use the engine throttle to control the water pressure / air pressure
4. Connect the air discharge hose to the fitting on the pump operator's panel and open the air supply valve.

Extended compressed air only operations necessitate connection of an external water source to the pump inlet and closing of the tank to pump valve for proper compressor cooling. In this case, cooling water will flow into the booster tank at 10-20 GPM, eventually overflowing the tank.

## C. For Manual Auto-Sync



Figure 2 Manual Auto-sync panel

## I. Water Pumping Operations

All unit operations begin with pumping water. These steps must be followed for operations involving pumping water, foam solution, compressed air or compressed air foam.

1. Connect the hose(s) to the desired discharge(s).

---

**WARNING:** Prior to starting the engine, the Auto Sync controls should be in the UNLOAD position, which allows the air compressor to “free wheel” without pumping air.

---

2. If pumping water from an on board booster tank, fully open the tank to pump valve.
3. If pumping from an overboard source, the tank to pump valve should be fully closed.
4. If so equipped, turn on the main power switch to the CAFS unit.
5. Start the engine.
6. Throttle-up to desired pressure. If pump pressure is absent, it will be necessary to prime the pump utilizing the Waterous Jet Primer. The Jet Primer utilizes compressed air from the onboard compressor system, which is passed through a venturi, creating a vacuum within the water pump.
  - To prime, move the Auto-Sync controls to the FIXED/RUN position to build air pressure.
  - Once air pressure has risen, move the Jet Primer to the open position. The rush of air through the priming venturi will be audible.
  - As water is drawn into the pump, some will be vented through the venturi and spill onto the ground. When the water discharge pressure gauge rises, the pump is primed.

- After prime is achieved, close the Jet Primer. For water only operations, move the Auto-Sync controls back to the AUTO/UNLOAD position.
7. Open desired discharge valve(s) and throttle-up to desired pressure.

---

**CAUTION:** Running the unit with a dry fire pump can cause damage to the pump and air compressor system.

---

## II. Foam Solution Operations

Follow the instructions above for water pumping operations.

Turn on the foam proportioner to inject foam concentrate into the water stream. Refer to the foam proportioner operation manual for instructions in the proper operation of the installed proportioning system.

## III. Compressed Air Foam Operations

Follow the instructions above for foam solution operations. Safe operations dictate the presence of foam concentrate in the water stream prior to the injection of compressed air. If foam concentrate is not present, a condition known as “slug flow” will occur. This is where unmixed water and air is discharged through a nozzle in an erratic manner.

1. Set water discharge pressure at the desired level. Discharge pressures for “Compressed Air Foam Operations”, typically range between 80 and 120 PSI in a flow state.

**NOTE:** Compressed air foam does not have the hydraulic characteristics of plain water or foam solution. Therefore, standard pump hydraulics practices do not apply to CAFS operations.

2. Move Auto-Sync controls to the AUTO/RUN position.  
Air pressure as shown on the air pressure gauge should rise to within plus or minus 5% of the water discharge pressure. The Auto-Sync system will balance the air and water pressures throughout a range of 40 PSI up to 150 PSI. Optimal compressed air foam system performance occurs at discharge flow pressures of 80-120 PSI.
3. Set proportioner at 0.2% - 0.6% for normal Class A combustibles.  
The type and brand of foam concentrate used and the tactical objective, dictate proportioning rates.
4. Open desired discharge valve(s).  
Controlling the amount of foam solution entering the discharge stream sets the foam expansion ratio. High solution flows restrict the amount of air admitted and result in lower expansion or “wet” foam. To produce higher expansion or “drier” foam, simply gate back the amount of solution admitted.
5. Fully open the air valve(s) to the desired discharge(s).
6. Adjust the solution flow to produce the desired foam consistency.

Foam is formed during the transition through the hose. To produce acceptable finished foam, sufficient hose length must be provided on the discharge. Refer to the section "Suggested Guidelines for the Production of Mid-Range Compressed Air Foam".

---

**WARNING:** Nozzle reaction force is significantly increased at the time the nozzle valve is opened in compressed air foam operations. OPEN CAFS NOZZLES SLOWLY!

---

## IV. Compressed Air Only Operation

Follow instructions for water pumping operations without opening discharge valves. Air compressor cooling is via water that is circulated by the fire pump through the compressor cooler and returned back to the booster tank. During this operation, time is limited by the amount of available cooling water.

The water in the booster tank will eventually become heat saturated and ineffective at cooling the air compressor. Watch the compressor temperature gauge closely! Maximum is 250°F. Compressor system overheat is also indicated by the panel mounted warning light and alarm.

1. After engine start, ensure that the water pressure as shown on the panel mounted gauge rises.
2. Move Auto-Sync control to the FIXED/RUN positions. Air pressure will rise to the preset pressure setting on the air compressor, approximately 150-PSI with the engine throttled-up.
3. For lower operating pressures, move the Auto-Sync controls to the AUTO/RUN positions and use the engine throttle to control the water pressure / air pressure
4. Connect the air discharge hose to the fitting on the pump operator's panel and open the air supply valve.

Extended compressed air only operations necessitate connection of an external water source to the pump inlet and closing of the tank to pump valve for proper compressor cooling. In this case, cooling water will flow into the booster tank at 10-20 GPM, eventually overflowing the tank.

## D. Shut-Down Procedure

- Close air valve(s)
- Turn off Foam proportioner
- Flow clear water through discharge hose(s) until no bubbles are present
- Close discharge valve(s)
- Move Auto-Sync controls to (for Manual)=UNLOAD/AUTO  
(for Electric)= UNLOAD
- Shut engine down

After the engine is shut down, the compressor system will vent itself, creating an audible hiss as compressed air is evacuated from the pressure vessel / sump.

---

---

### WARNINGS

- Compressed air can be dangerous. Read and understand the operating instructions for the Waterous compressed air foam unit and individual components prior to operating.
  - DO NOT use the compressed air foam unit as an air source for SCBA or any breathing air supply.
  - Discharge outlets that are capped, hose lines that are valved and charged and the air compressor sump may contain compressed air. Relieve all pressure BEFORE attempting to remove any caps, fittings, and nozzles or to perform maintenance to prevent serious personal injury.
  - Nozzle reaction force is significantly increased at the time the nozzle valve is opened in compressed air foam operations. OPEN CAFS NOZZLES SLOWLY!
  - Operating the compressed air foam unit with water and compressed air pumped through a discharge without foam concentrate will create a potentially dangerous condition known as "slug flow"; where unmixed pockets of water and air are passed through the nozzle, causing erratic nozzle reaction.
  - For compressed air foam operations, use only fire hose that is rated at 200 PSI or higher working pressure.
  - The unit operator should have a thorough understanding of "Boyle's Law" (The law of compressed gases) prior to operating the compressed air foam unit.
- 
-

## SECTION 2. AIR COMPRESSOR

### A. How It Works

The air compressor used in this application is a GHH-RAND model CF75D, oil flooded rotary screw type. Rotary screw air compressors are very common in industrial applications. This type of compressor injects oil into itself, where it lubricates, seals, cools, and silences the compressor. The oil is then entrained into the air discharge from the compressor. This air/oil mixture is discharged into a sump tank where most of the oil separates from the air. The oil is then sent via hydraulic hose to a combination unit. It is cooled to remove compression and friction heat, filtered, and sent to the oil injection port on the compressor. The cycle is then repeated.

The oil mist that remains in the air stream is recovered by an air/oil separator system. This system recovers the oil mist in a spin-on cartridge that has a siphon tube that picks-up the recovered oil for return to the air compressor.

A modulating inlet valve controls the compressor's air output. The inlet valve is opened and closed by the Auto Sync pressure control system.

The compressor cooling system circulates water from the fire pump through the compressor oil cooler and back to the tank to remove heat from the compressor oil system. The compressor oil temperature should not exceed 250 degrees F. If this occurs, check the water supply, pump prime, restrictions in the cooling water system and for low oil level in the sump.

The air compressor (air end) is mounted to the transmission of a Waterous CPT-2 single stage pump and driven by a dry Poly Chain. The pump / air end are directly driven by the engine. It is important to ensure that there is a water supply to the pump whenever the engine is running. Pump and/or compressor damage may result from running the pump dry.

## SECTION 3. SYSTEM SERVICE AND MAINTENANCE

Excessive heat build-up and oil system contamination are the most common causes of compressor system problems and premature wear. With proper operation and maintenance, the compressor system should far outlast the vehicle it is mounted on.

Adherence to the following guidelines may prevent potentially costly damage.

1. There is a sight gauge provided on the oil reservoir and visible through a hole on the pump panel. The oil level should be at approximately halfway up the window. Check the oil on level ground, prior to system start up. If the system has recently been run, wait 10 minutes after shutdown for the oil to stabilize before checking the oil level. The compressor uses common hydraulic oil. This oil is classified by an ISO standard as ISO 68 viscosity and is sold under various trade names. Many are sold as "anti wear" hydraulic oil and are available from auto parts or lubricating oil suppliers.
2. The oil should be changed after the first 30 hours of system operation. After that, the oil should be changed annually. There is a drain plug located at the bottom of the sump. The oil fill cap is located on end of the unit.
3. Change the compressor system oil filter at the same time as the oil is changed. The spin-on filter cartridge is a Mann/Hummel hydraulic oil filter. Call Waterous for replacement elements.
4. Run the compressor for 2 minutes after changing the oil, then re-check the oil level and add oil as necessary. **DO NOT OVERFILL.**
5. Visually inspect the compressor oil system weekly for signs of leaks. Check the air compressor Poly Chain drive for proper tension and signs of wear monthly or more frequently as dictated by the amount of use. Proper tension on the poly chain is to a no slack setting, (If in Doubt, **Do Not** Tighten the Poly Chain). A slightly loose poly chain is acceptable. An over tight poly chain may cause equipment failure and may void product warranty.
6. Inspect the compressor air intake filter and clean or replace as necessary. The environment in which the unit operates will determine the frequency of air filter service and replacement. In any situation, replace no less frequently than yearly.
7. Replace the separator cartridge every 24 months, or if the unit's oil consumption suddenly increases. A sudden increase may be caused by a hole in the internal media of the cartridge allowing oil to carry through and discharge with the compressed air. Call Waterous for replacement separator cartridges.
8. Completely drain the water from the compressor oil cooler in cold weather to prevent freeze damage.

### A. Maintenance Schedule

	Check Oil Level & for Oil Leaks	Change Compressor Oil	Change Oil Filter	Change Separator Cartridge
Daily or After Each Use	<b>X</b>			
Annually		<b>X</b>	<b>X</b>	
Every 24 Months				<b>X</b>

Refer to the Engine Manual for recommended engine maintenance.

### B. Maintenance Items

<b>ENGINE</b>			
			Part#
AIR FILTER:	CO85004 <sup>(1)</sup>		2030042
FUEL SEPARATOR FILTER:	FF 5432 <sup>(4)</sup>		2030102
OIL FILTER:	C6002112110 <sup>(4)</sup>		2030039
	LF 116011 <sup>(5)</sup>		
<b>COMPRESSOR</b>			
			Part#
AIR FILTER:	CO85003 <sup>(1)</sup>		2030041
SEPARATOR FILTER:	LB 13 145/3 <sup>(2)</sup>		2030049
HYDRAULIC FILTER:	WD 962 <sup>(2)</sup>		2030060
<b>HYDRAULIC OIL</b>			
ISOAUW68 Anti-Wear, Low-Foaming, Anti-Foaming			
<b>BELTS</b>			
			Part#
POLY CHAIN:	8MGT-1000-36 <sup>(3)</sup>		1030014
Engine V-Belt:	C0412021748 <sup>(4)</sup>		1030035
	17480 <sup>(6)</sup>		

(1) = Donaldson    (2) = Mann & Hummel    (3) = Gates    (4) = Cummins  
 (5) = Fleetpride    (6) = Dayco

## C. Wye Strainer for Cooler

A wye-strainer is provided to strain water before it enters the cooler's water inlet. The wye strainer requires regular inspection, and should be in an easily accessible location for inspection, removal, and cleaning.

---

**Caution:** Waterous is not responsible for damage due to plugged strainers. If the customer's water system contains excessive debris, or the vehicle relies on drafting for its water supply, it may be necessary to install a larger strainer and/or a clean-out valve on the wye-strainer.

---

Without good water flow through the heat exchanger, the compressor will overheat. Compressor performance will be inadequate, and it may fail completely.

Omitting the Wye-strainer or removing the screen from the Wye does not improve water flow. It will allow debris into the cooler, which can clog the tiny heat exchanger tubes and restrict water flow.



Figure 3 Wye Strainer



Figure 4 Wye-strainer installed, with cleanout valve.

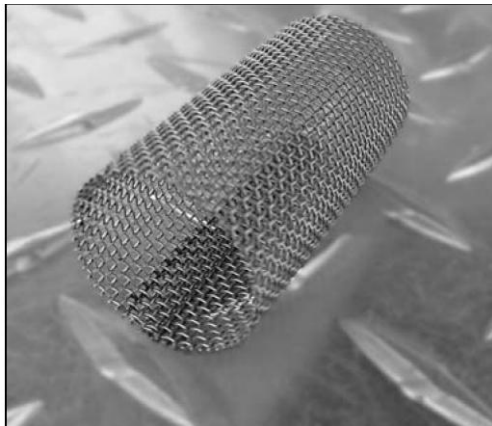

Figure 5 Clean Strainer



Figure 6 Dirty Strainer

## SECTION 4. CAFS NOZZLE / FLOW RATE / HOSE COMBINATIONS

### A. Nozzles

Compressed air foam can be discharged through various types and sizes of nozzles. Fog nozzles breakdown the bubble structure of the foam. This results in "wetter" or reduced expansion foam. The preferred way to make foam is utilizing smooth bore nozzles with a given hose diameter. Smaller tips will discharge "wetter" foam.

### B. Foam Concentrate Ratios

Proportioner settings of 0.2% and 0.6% are typically adequate to produce compressed air foam that is formed in a hose line and used on Class A combustibles. Higher settings will result in "drier" appearing foam. Lower settings may result in "slug flow" or discharge pulsation caused by insufficient foam concentrate in solution to form foam in the hose line.

For Class B or other type foam ratio settings, follow the instructions provided by the foam concentrate manufacturer.

### C. Hose

Utilize fire hose that is rated by the hose manufacturer for use with CAFS. Since the foam is formed during its transition through the hose line, it is important to utilize the minimum recommended hose lengths, unless a static mixer is utilized. There is significantly less friction and head loss with compressed air foam as compared to water or foam solution. Hence, effective fire streams can be achieved with longer hose lays. Refer to the "Suggested Guidelines for the Production of Mid-Range Compressed Air Foam".

**NOTE:** Compressed air foam systems have the ability to produce foam of shaving cream consistency. While this type of foam is highly stable and possesses a long drain time, it is essential to ensure that the foam will release sufficient water to extinguish a fire in a direct attack situation. This type of foam is typically suited for defensive operations such as exposure protection, barriers or fuels pretreatment.

## SECTION 5. SUGGESTED GUIDELINES FOR THE PRODUCTION OF MID-RANGE COMPRESSED AIR FOAM

### A. 1" (25 mm) Hose Diameter Jacketed

#### 1 GPM to 1 CFM

½" Tip Solution Flow: 15 GPM (56.78 LPM)

Air Flow: 15 CFM (0.42 m<sup>3</sup>/min)

Disch. Pressure: 100-150 PSI (6.804 - 10.206 BAR) (689.5 - 1034.25 KPA)

Min/Max Hose Length: 35' to over 400' (10.668 – 121.92 meters)

#### 2 GPM to 1 CFM

½" Tip Solution Flow: 30 GPM (113.56 LPM)

Air Flow 15 CFM (0.42 m<sup>3</sup>/min)

Disch. Pressure: 100-150 PSI (6.804 - 10.206 BAR) (689.5 - 1034.25 KPA)

Min/Max Hose Length: 35' to over 400' (10.668 – 121.92 meters)

#### 1 GPM to 1 CFM

¾" Tip Solution Flow: 20 GPM (75.71 LPM)

Air Flow: 20 CFM (0.56 m<sup>3</sup>/min)

Disch. Pressure: 100-150 PSI (6.804 - 10.206 BAR) (689.5 - 1034.25 KPA)

Min/Max Hose Length: 35' to over 200' (10.668 – 60.96 meters)

#### 2 GPM to 1 CFM

¾" Tip Solution Flow: 40 GPM (151.41 LPM)

Air Flow: 20 CFM (0.56 m<sup>3</sup>/min)

Disch. Pressure: 100-150 PSI (6.804 - 10.206 BAR) (689.5 - 1034.25 KPA)

Min/Max Hose Length: 35' to over 200' (10.668 – 60.96 meters)

### B. 1-1/2" (38 mm) Hose Diameter

#### 1 GPM to 1 CFM

1" Tip Solution Flow: 30-40 GPM (113.56 – 151.41 LPM)

Air Flow: 30-40CFM (0.84 – 1.12 m<sup>3</sup>/min)

Disch. Pressure: 100-150 PSI (6.804 - 10.206 BAR) (689.5 - 1034.25 KPA)

Min/Max Hose Length: 100' to over 800' (30.48 – 243.84 meters)

#### 2 GPM to 1 CFM

1" Tip Solution Flow: 60-80 GPM (227.12 – 302.82 LPM)

Air Flow: 30-40CFM (0.84 – 1.12 m<sup>3</sup>/min)

Disch. Pressure: 100-150 PSI (6.804 - 10.206 BAR) (689.5 - 1034.25 KPA)

Min/Max Hose Length: 100' to over 800' (30.48 – 243.84 meters)

**1 GPM to 1 CFM**

1-3/8" Tip Solution Flow: 50-60 GPM (189.27 – 227.12 LPM)

Air Flow: 50-60 CFM (1.4 – 1.68 m<sup>3</sup>/min)

Disch. Pressure: 100-150 PSI (6.804 - 10.206 BAR) (689.5 - 1034.25 KPA)

Min/Max Hose Length: 100' to over 800' (30.48 – 243.84 meters)

**2 GPM to 1 CFM**

1-3/8" Tip Solution Flow: 90-120 GPM (340.68 – 454.24 LPM)

Air Flow: 50-60 CFM (1.4 – 1.68 m<sup>3</sup>/min)

Disch. Pressure: 100-150 PSI (6.804 - 10.206 BAR) (689.5 - 1034.25 KPA)

Min/Max Hose Length: 100' to over 800' (30.48 – 243.84 meters)

**C. 1-3/4" (44 mm) Hose Diameter****1 GPM to 1 CFM**

1" Tip Solution Flow: 30-40 GPM (113.56 – 151.41 LPM)

Air Flow: 30-40 CFM (0.84 – 1.12 m<sup>3</sup>/min)

Disch. Pressure: 100-150 PSI (6.804 - 10.206 BAR) (689.5 - 1034.25 KPA)

Min/Max Hose Length: 100' to over 1400' (30.48 – 426.72 meters)

**2 GPM to 1 CFM**

1" Tip Solution Flow: 60-90 GPM (227.12 – 340.68 LPM)

Air Flow: 30-50 CFM (0.84 – 1.4 m<sup>3</sup>/min)

Disch. Pressure: 100-150 PSI (6.804 - 10.206 BAR) (689.5 - 1034.25 KPA)

Min/Max Hose length: 100' to over 1400' (30.48 – 426.72 meters)

1-3/8" Tip Solution Flow: 50-90 GPM (189.27 – 340.68 LPM)

Air Flow: 50-80 CFM (1.4 – 2.24 m<sup>3</sup>/min)

Disch. Pressure: 110-150 PSI (7.4844- 10.206 BAR) (758.45- 1034.25 KPA)

Min/Max Hose Length: 100' to over 700' (30.48 – 213.36 meters)

**NOTE:** With 1-3/4" hose lengths of 100'-250' (30.48 – 76.2 meters), up to 90-120 GPM (340.68 – 454.24 LPM) of water and 40-100 CFM (1.12 – 2.8 m<sup>3</sup>/min) of air may be utilized as a highly effective initial attack flow.

System flows are very flexible. The flow of any discharge can vary according to the situation and conditions.

It is possible to make the discharge stream wetter or drier by changing the amount of solution or air in the hose.

The stream can also vary by changing the tip size at the nozzle.

- The bigger the diameter tip, the drier the foam.
- The smaller the diameter tip, the wetter the foam.

## D. Master Stream

### **1" Tip Solution Flow:**

90-120 GPM (340.68 – 454.24 LPM)

Air Flow: 60-80 CFM (1.68 – 2.24 m<sup>3</sup>/min)

### **1-3/8" Tip Solution Flow:**

100-150 GPM (378.53 – 567.80 LPM)

Air Flow: 70-100 CFM (1.96 – 2.8 m<sup>3</sup>/min)

### **1-1/2" Tip Solution Flow:**

120-200 GPM (454.24 – 757.06 LPM)

Air Flow: 80-120 CFM (1.68 – 3.36 m<sup>3</sup>/min)

### **1-3/4" Tip Solution Flow:**

180-250 GPM (681.35 – 946.33 LPM)

Air Flow: 120-150 CFM (3.36 – 4.2 m<sup>3</sup>/min)

### **2" Tip Solution Flow:**

250-450 GPM (946.33 – 1703.39 LPM)

Air Flow: 200 CFM (5.6 m<sup>3</sup>/min)

Disch. Pressure: 120-150 PSI (8.1648 – 10.206 BAR) (827.4 – 1034.25 KPA)

## SECTION 6. TROUBLESHOOTING

### A. CAFS

Observed Symptom	Probable Cause	Suggested Remedy
Lack of air pressure from compressor	Lack of air supply to clutch (for air-clutch systems)	Repair air leak or re-establish air supply
Compressor not engaging	No PTO engagement	Confirm OK TO PUMP light is on, if not check wiring for damage or disconnected wire, check PTO.
Compressor engaging. No air supply to discharges or insufficient air supply.	Auto-Sync switches not in correct position.	Confirm 40 PSI in UNLOAD position (200 CFM systems) and 50+ in run position. Smaller compressors have lower UNLOAD pressures. Verify when in FIXED/RUN whether pressure reflects 145-150 PSI
	(electric valves) Verify there is power to the air solenoid and check operation of solenoid.	Air discharge solenoid not working. Repair/replace solenoid  Air solenoid working - leak between solenoid and discharge. Repair leak.
	Air check valve defective	Replace or correct installation.
	Trim valve out of adjustment	Refer to trim valve instructions
	Restricted minimum pressure valve	Clean rust or debris from valve
	Air plumbed before discharge valve seal	Relocate to discharge side of discharge valve
	Incorrect air line size	Size according to discharge and replace line with correct size.
System functioning correctly, pressure gauge reading obviously incorrect.	Gauge malfunction, air line detached	Check for air leaks, replace gauge
FIXED has pressure but AUTO has no pressure	No water supply to balance valve.	Check line for proper installation, with no kinks or obstructions. Refer to trim valve instructions.
Air discharge pressure too high	Red hose circuit (compressed air control) has leak or is disconnected.	Repair leak or attach hose

Observed Symptom	Probable Cause	Suggested Remedy
System overheating	Inadequate water flow through cooler	Ensure adequate water flow through pump. Check Y strainer for obstruction, clean and reinstall Drain and flush cooler water tubes
	Adequate water flow through cooler.	On-board tank used for cooling for a prolonged period - water too hot to effectively cool the compressor. Locate source of lower temperature water.  Check oil level -  Adjust level to half of the sight glass on level surface.
	Low compressor oil level:	Check the hydraulic lines for kinks  Change oil filters
	Temperature sending unit and or gauge circuit malfunction.	Check wire connections at sending unit
High Oil Consumption	Overfull compressor oil	Adjust level to half of the sight glass on level surface.
	Excess of 200 CFM air flow (on 200 CFM systems)	Back down RPM's and flow CAFS to relieve pressure, then recheck  Replace Air/Oil Separator Filter
	Air/oil Separator Filter torn or damaged (could be caused by air flow of higher than 200CFM)	System being operated at higher than capacity
"Excessive" compressor bleed down time on shutoff	Systems vary in bleed down time.	If Auto-Sync is operating correctly, and compressor output is within spec, do nothing.
Engine stalls upon compressor engagement	Engaging compressor while under load	Allow compressor to bleed down before re-engagement
	Running system without flowing air causes oil to accumulate in compressor acting like hydraulic pump	Bleed down air, restart compressor, and move air
	Underrated engine horsepower	Raise engine RPM
	Auto-Sync in FIXED / RUN setting	Engage in AUTO/UNLOAD, then switch to FIXED/RUN
	High oil level	Check oil level, adjust level to half of the sight glass with vehicle parked on a level surface
	Compressor locked up	Repair/replace compressor

Observed Symptom	Probable Cause	Suggested Remedy
Compressor locked up	High oil level (compressor is flooded)	Check oil level, adjust level to half of the sight glass with vehicle parked on a level surface
	Sump fire	Check system and repair
	Low oil level or no oil	Check system and repair
Air flow meter stuck at "0" CFM	Magnet uncoupled in meter	Turn air flow on and off to re-couple
Air flow meter stuck at high CFM		Move large amounts of air out discharge and turn air flow on and off to re-couple
Poor foam (wet or dry) or no foam (assuming air pressure to discharges is OK)	Using wetting agent and not foam concentrate.	Use foam concentrate
	Foam proportioning control turned too low.	Increase amount of concentrate delivered to manufacturer recommended amount.
	Foam proportioning control OFF or turned too low, foam tank empty.	Make sure proportioner is turned on, foam supply valve is open, foam tank has concentrate, Y strainer is clean, and supply line is connected to injector.
Discharge hose shaking (slug flow)	Foam proportioner ON, setting correct, and tank has foam concentrate, but not providing foam solution.	Refer to foam proportioner manufacturer's instructions for detailed calibration and troubleshooting instructions
Foam in the water system (when proportioner turned off)	Foam concentrate was poured into the on-board water tank	Flush tank and pump with clean water, refill
	Foam manifold drain lines not isolated from water drain lines	Isolate to separate drain valve
	Cooler line plumbed from foam manifold	Relocate line to discharge side of pump
	Foam manifold check valve defective	Rebuild/replace check valve
Water in compressor oil/air	Leaking inside cooler Freeze damage	Isolate cooler and check for leaks, replace if needed, check drain
	Defective air check valves	Replace or check
	Missing air check valves for discharges	Install check valves

Observed Symptom	Probable Cause	Suggested Remedy
Clutch smoking	Engaging in RUN position	Engage in AUTO/UNLOAD only
	Slight air leak from solenoid to clutch	Repair air leak
	High RPM engagement	Engage in lower RPM
	Not allowing compressor to bleed down before engaging clutch again	Allow for bleed down
	Contaminated clutch disc	Clean or replace
Safety pop off valve opening at low pressure	Auto-Sync system out of balance	Adjust the Auto-Sync system, making sure to not open the trim valve on the compressor more than 3 turns.
	Sump fire damaged pop off valve	Check system for other damage and replace valve
Safety pop off valve repeatedly opening	Trim valve or inlet completely open	Refer to trim valve instructions

## B. Pump

Observed Symptom	Probable Cause	Suggested Remedy
Pump fails to prime or loses prime	Air leaks	<p>Clean and tighten all Intake connections. Make sure intake hoses and gaskets are in good condition.</p> <p>Use the following procedure to locate air leaks:</p> <ol style="list-style-type: none"> <li>1. Connect Intake hose to pump and attach Intake cap to end of hose.</li> <li>2. Close all pump openings.</li> <li>3. Open priming valve and operate primer until vacuum gage Indicates 22 in. Hg/.735 atmospheres. (If primer fails to draw specified vacuum, it may be defective, or leaks are too large for primer to handle.)</li> <li>4. Close priming valve and shut off primer. If vacuum drops more than 10 in. Hg/.334 atmospheres In 5 minutes, serious air leaks are indicated. With engine stopped, air leaks are frequently audible. If leaks cannot be heard, apply engine oil to suspected points and watch for break in film or oil being drawn into pump.</li> </ol>
		<ol style="list-style-type: none"> <li>1. Completely fill water tank (if so equipped).</li> <li>2. Connect intake hose to hydrant or auxiliary pump.</li> <li>3. Open one discharge valve and run in water until pump is completely filled and all air is expelled.</li> <li>4. Close discharge valve, apply pressure to system and watch for leaks or overflowing water tank. A pressure of 100 psi is sufficient.</li> </ol> <p style="text-align: center;"><b>DO NOT EXCEED RECOMMENDED PRESSURE.</b></p>
		<ol style="list-style-type: none"> <li>1. If pump has not been operated for several weeks, packing may be dried out.</li> <li>2. Close discharge and drain valves and cap intake openings.</li> <li>3. Operate primer to build up a strong vacuum In pump.</li> <li>4. Run pump slowly and apply oil to Impeller shaft near packing gland.</li> <li>5. Make sure packing is adjusted properly.</li> </ol>
	Dirt on Intake strainer	Remove all leaves, dirt and other foreign material from Intake strainer.
		<p>When drafting from shallow water source with mud, sand or gravel bottom, protect intake strainer In one of the following ways:</p> <ol style="list-style-type: none"> <li>1 Suspend Intake strainer from a log or other floating object to keep It off the bottom. Anchor float to prevent it from drifting Into shallow water.</li> <li>2. Remove top from a clean barrel. Sink barrel so open end is below water surface. Place Intake strainer Inside barrel.</li> <li>3. Make an Intake box, using fine mesh screen. Suspend intake strainer Inside box.</li> </ol>
	No oil In priming tank	With rotary primer, oil is required to maintain a tight rotor seal. Check priming tank oil supply and replenish, if necessary.

Observed Symptom	Probable Cause	Suggested Remedy
Pump fails to prime or loses prime (cont'd)	Defective priming valve	A worn or damaged priming valve may leak and cause pump to lose prime. Consult primer Instructions for priming valve repair.
	Improper clearance in rotary gear or vane primer	After prolonged service, wear may increase primer clearance and reduce efficiency. Refer to primer Instructions for adjusting primer clearance.
	Engine speed too low	Refer to Instructions supplied with primer for correct priming speeds. Speeds much higher than those recommended do not accelerate priming, and may actually damage priming pump.
	Bypass line open	If a bypass line is installed between the pump discharge and water tank to prevent pump from overheating with all discharge valves closed, look for a check valve in the line. If valve is stuck open, clean it, replace it or temporarily block off line until a new valve can be obtained.
	Lift too high	Do not attempt lifts exceeding 22 feet (6.7m) except at low altitudes and with equipment in new condition.
	End of Intake hose not submerged deep enough	Although Intake hose might be immersed enough for priming, pumping large volumes of water may produce whirlpools, which will allow air to be drawn into intake hose. Whenever possible, place end of Intake hose at least two feet below water source.
	High point in Intake line	If possible, avoid placing any part of Intake hose higher than pump inlet. If high point cannot be prevented, close discharge valve as soon as pressure drops, and prime again. This procedure will usually eliminate air pockets in intake line, but it may have to be repeated several times.
	Primer not operated long enough	Refer to Instructions supplied with primer for required priming time. The maximum time for priming should not exceed 45 seconds for lifts up to 10 feet (3.0m).
Insufficient capacity A. Engine and pump speed too low at full throttle (continued)	Insufficient engine power	Engine requires maintenance. Check engine in accordance with manufacturer's instructions supplied with truck.
		Engine operated at high altitudes and/or high air temperatures. Engine power decreases with an increase in altitude or air temperature, except for turbo charged engines. Adjusting carburetor or changing carburetor jets (or injector nozzles) may improve engine performance. Consult with engine manufacturer.
Discharge relief valve set improperly	If relief valve is set to relieve below desired operating pressure, water will bypass and reduce capacity. Adjust relief valve in accordance with instructions supplied with valve.	
Insufficient capacity A. Engine and pump speed too low at full throttle (continued)	Transfer valve set improperly (Does not apply to single stage pumps.)	Place transfer valve in VOLUME (parallel) position when pumping more than two thirds rated capacity.
		When shifting transfer valve, make sure it travels all the way into new position. Failure of transfer valve to move completely into new position will seriously impair pump efficiency.
	Truck transmission in too high a gear	Consult vehicle instructions for correct pump gear. Pump usually works best with transmission in direct drive. If truck is equipped with an automatic transmission, be sure transmission is in pumping gear.

Observed Symptom	Probable Cause	Suggested Remedy
Insufficient capacity B. Engine and pump speed higher than specified for desired pressure and volume (continued)	Transfer valve set Improperly	Place transfer valve In VOLUME (parallel) position when pumping more than two thirds rated capacity.
	(Does not apply to single stage pumps.)	When shifting transfer valve, make sure it travels all the way Into new position. Failure of transfer valve to move completely into new position will seriously impair pump efficiency.
	Pump Impeller(s) or wear rings badly worn	Install undersize wear rings if Impeller to wear ring clearance is within limits indicated in MAINTENANCE INSTRUCTIONS. If not, install new impeller(s) and wear rings.
	Intake strainer, Intake screens or impeller vanes fouled with	Remove intake strainer and hose, and clear away all debris. Pressure backwash (preferably in parallel or "volume" position) will usually clear impeller vanes when pump Is stopped.
	Intake hose defective	On old intake hoses, the Inner liner sometimes becomes so rough it causes enough friction loss to prevent pump from drawing capacity. Sometimes, the liner will separate from the outer wall and collapse when drafting. It Is usually Impossible to detect liner collapse, even with a light. Try drafting with a new intake hose; if pump then delivers capacity, It may be assumed that previous hose was defective.
Intake hose too small	When pumping at higher than normal lifts, or at high altitudes, use a larger or additional Intake hoses.	
Insufficient capacity C. Engine speed higher than specified for desired pressure and volume	Truck transmission in too low a gear	Consult vehicle instructions for correct pumping gear. Pump usually works best with transmission in direct drive. (Check both engine and pump speed, if possible, to be sure transmission Is in "direct".)
Insufficient pressure	Pump speed too low	In general, the above causes and remedies for low pump capacity will also apply to low pump pressure. Check pump speed with a tachometer. If pump speed is too low, refer to engine manufacturer's instructions for method of adjusting engine speed governor.
	Pump capacity limits pump pressure	Do not attempt to pump greater volume of water at the desired pressure than the pump is designed to handle. Exceeding pump capacity may cause a reduction In pressure. Exceeding maximum recommended pump speed will produce cavitations, and will seriously Impair pump efficiency.
	Flap valve stuck open	When pump Is In PRESSURE (series), discharge will bypass to first stage Intake. Operate pump at 75 psi/52 bar, and rapidly switch transfer valve back and forth between positions. If this falls, try to reach valve with a stick or wire and work it free.

Observed Symptom	Probable Cause	Suggested Remedy
Relief Valve Malfunction	Sticky pilot valve	Disassemble and clean. Replace noticeably worn parts.
A. Pressure not relieved when discharge valves are closed	Plugged tube lines	Disconnect lines and Inspect.
Relief Valve Malfunction	Sticky pilot valve	Disassemble and clean. Replace noticeably worn parts.
B. Pressure will not return to original setting after discharge valves are reopened	Sticky main valve	Disassemble and clean. Replace noticeably worn parts.
C. Fluctuating pressure	Water surges (relief valve)	<p>Pressure fluctuation can result from a combination of intake and discharge conditions involving the pump, relief valve and engine.</p> <p>When the elasticity of the intake and discharge system and the response rate (reaction time) of the engine, pilot valve and relief valve are such that the system never stabilizes, fluctuation results.</p> <p>With the proper combination of circumstances, fluctuation can occur regardless of the make or type of equipment involved.</p> <p>Changing one or more of these factors enough to disrupt this timing should eliminate fluctuation.</p>
D. Slow response	Plugged filter or line	Clean lines and filter.

# SECTION 7. DRAWINGS

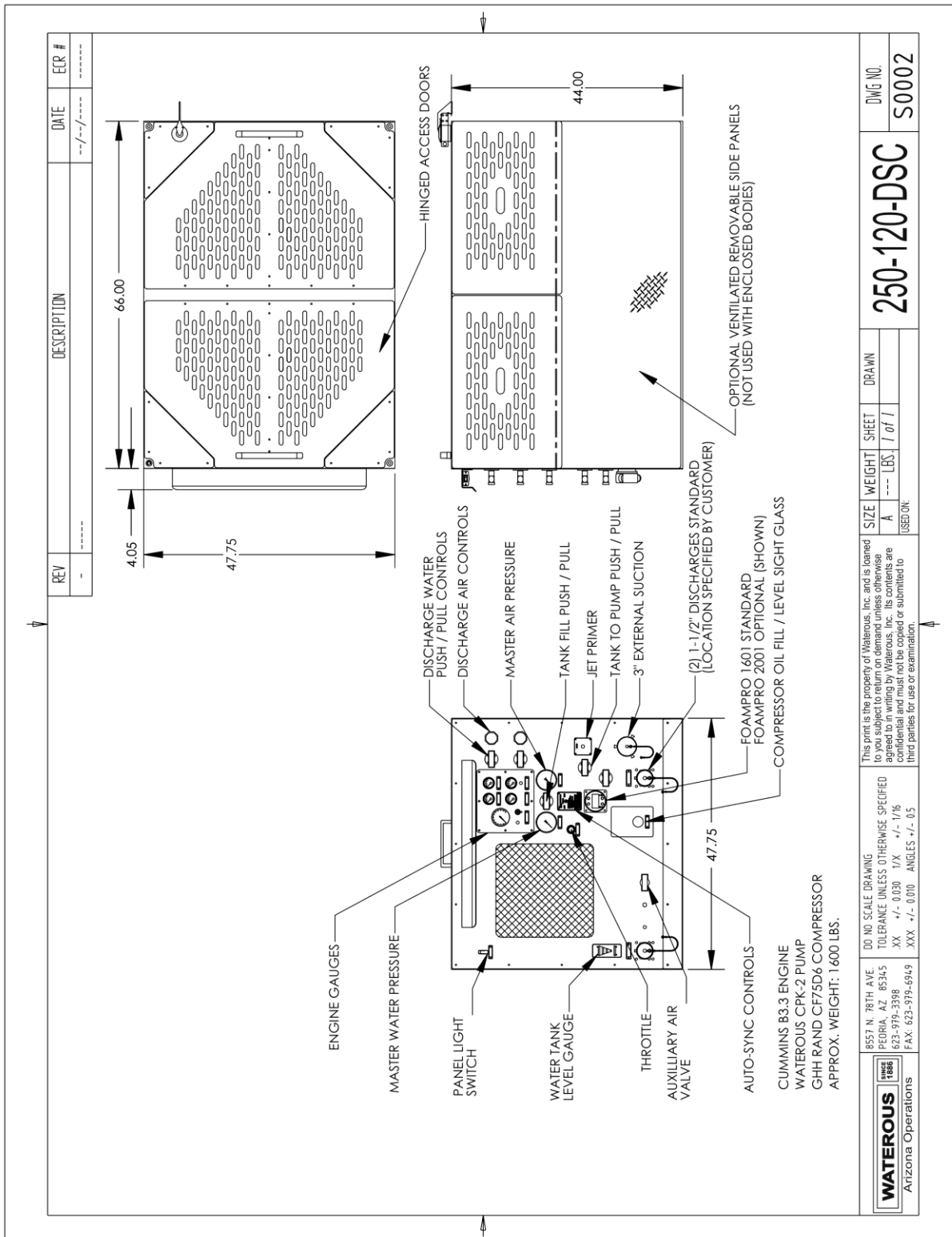

REV		DESCRIPTION		DATE	ECR #
---		---		---	---
SIZE		WEIGHT	SHEET	DRAWN	
A		---	1 of 1		
USED ON:					
DO NOT SCALE DRAWING TOLERANCE UNLESS OTHERWISE SPECIFIED XX +/- 0.030 1/8 +/- 1/16 XXX +/- 0.010 ANGLES +/- .05		This print is the property of Waterous, Inc. and is loaned to you subject to return on demand unless otherwise agreed to in writing by Waterous, Inc. Its contents are confidential and must not be copied or submitted to third parties for use or examination.			
8557 N. 78TH AVE. PEDRIA, AZ 85345 623-979-3398 FAX: 623-979-4949		<b>WATEROUS</b> Arizona Operations		DWG NO. <b>250-120-DSC</b> S0002	

Figure 7 Controls and Dimensions

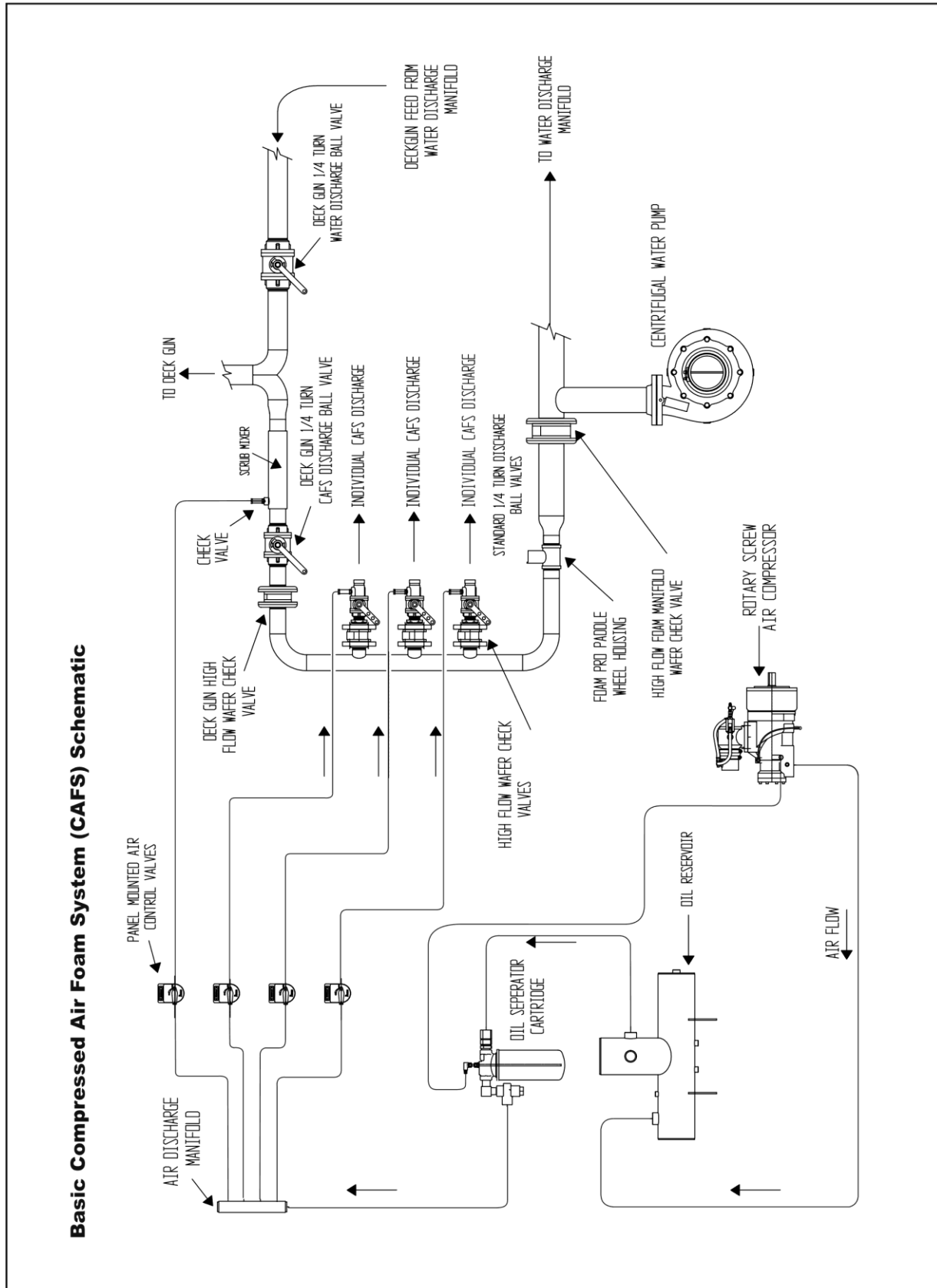
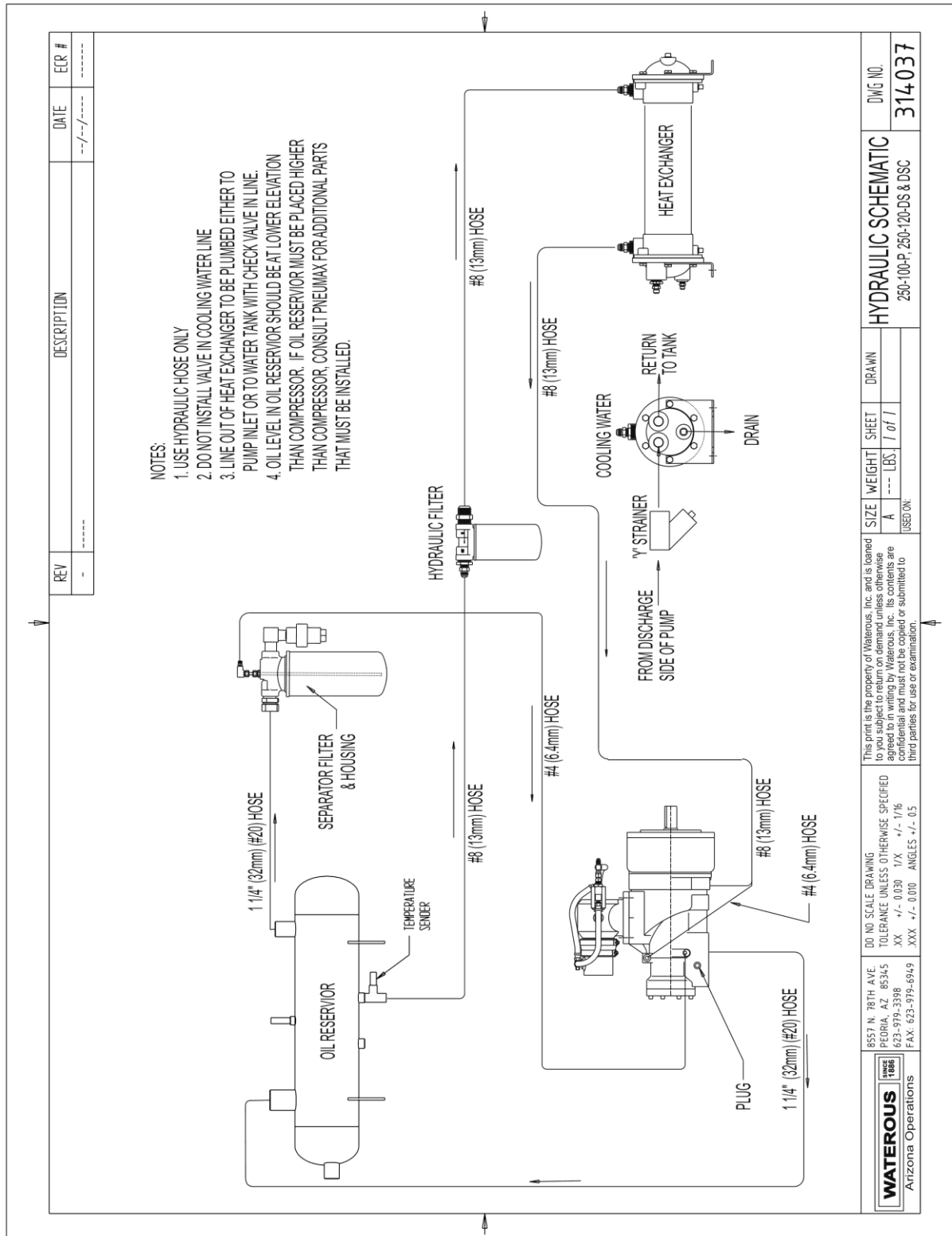

Figure 8 Basic CAFS Schematic



- NOTES:
1. USE HYDRAULIC HOSE ONLY
  2. DO NOT INSTALL VALVE IN COOLING WATER LINE
  3. LINE OUT OF HEAT EXCHANGER TO BE PLUMBED EITHER TO PUMP INLET OR TO WATER TANK WITH CHECK VALVE IN LINE.
  4. OIL LEVEL IN OIL RESERVIOR SHOULD BE AT LOWER ELEVATION THAN COMPRESSOR. IF OIL RESERVIOR MUST BE PLACED HIGHER THAN COMPRESSOR, CONSULT PNEUMAX FOR ADDITIONAL PARTS THAT MUST BE INSTALLED.

REV	DESCRIPTION	DATE	ECR #
-	----	--/--/----	----

<b>WATEROUS</b> Arizona Operations 8557 N. 78TH AVE. PEORIA, AZ 85345 623-979-3398 FAX: 623-979-6949	DO NOT SCALE DRAWING TOLERANCE UNLESS OTHERWISE SPECIFIED XX +/- 0.030 1/X +/- 1/16 XXX +/- 0.000 ANGLES +/- 0.5	This print is the property of Waterous, Inc. and is loaned to you subject to return on demand unless otherwise agreed to in writing by Waterous, Inc. Its contents are not to be copied or submitted to third parties for use or examination.	SIZE WEIGHT SHEET A --- LBS. / of /	DRAWN	HYDRAULIC SCHEMATIC 250-100-P, 250-120-JS & DSC	DWG NO. <b>314037</b>
	USED ON:					

Figure 9 Hydraulic Schematic

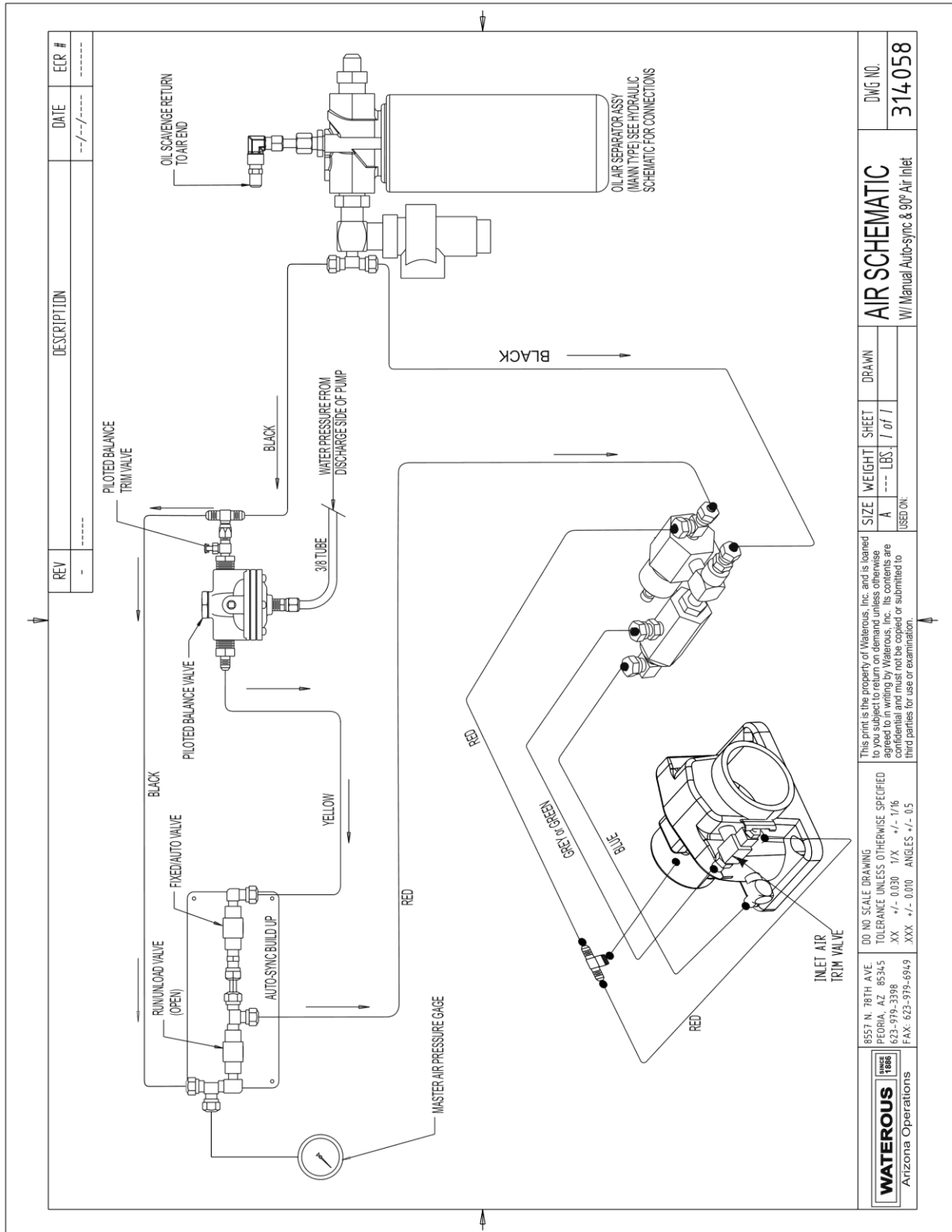

Figure 10 Air Schematic, Manual Auto-sync, 90° Inlet

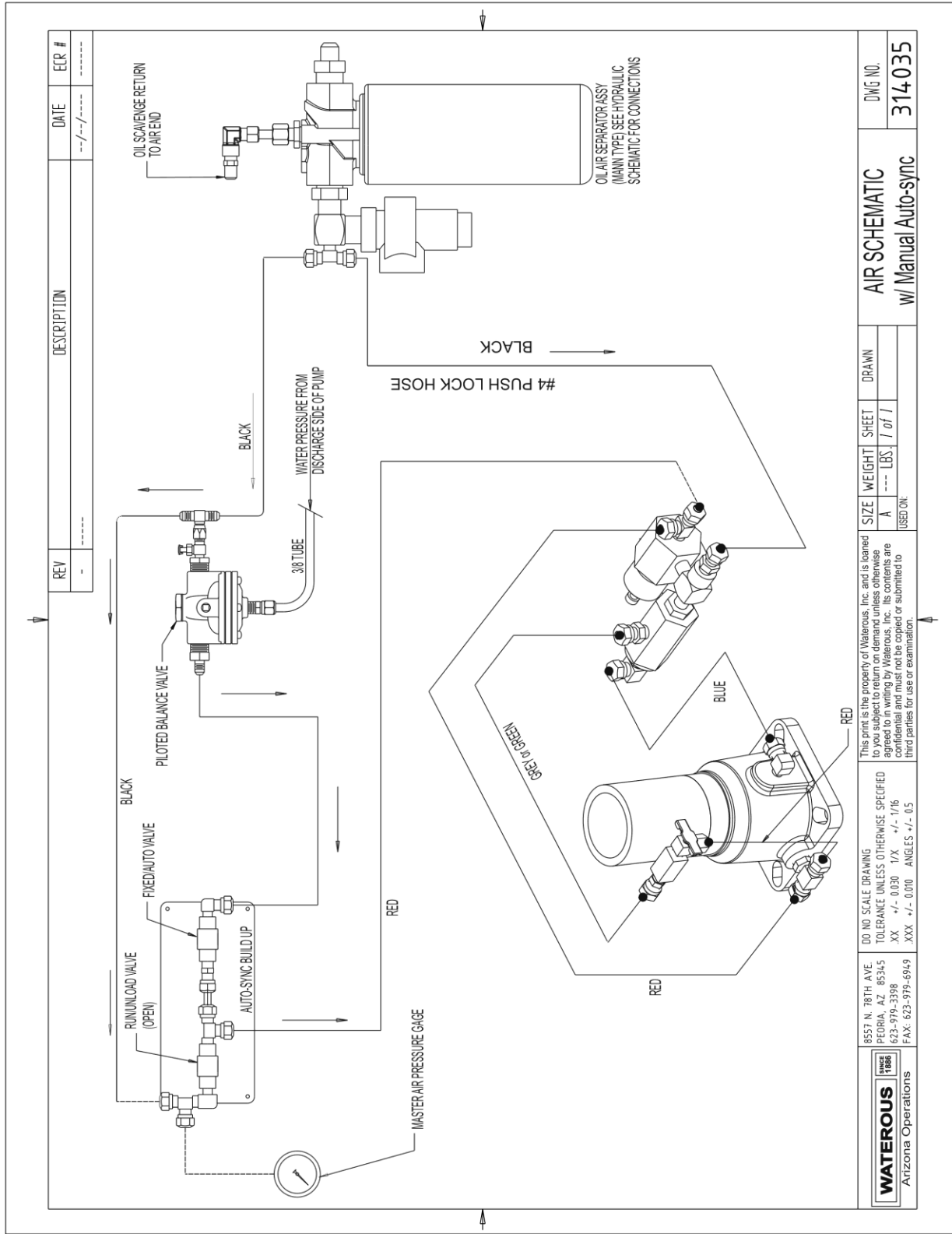

Figure 11 Air Schematic, Manual Auto-sync, Vertical Inlet

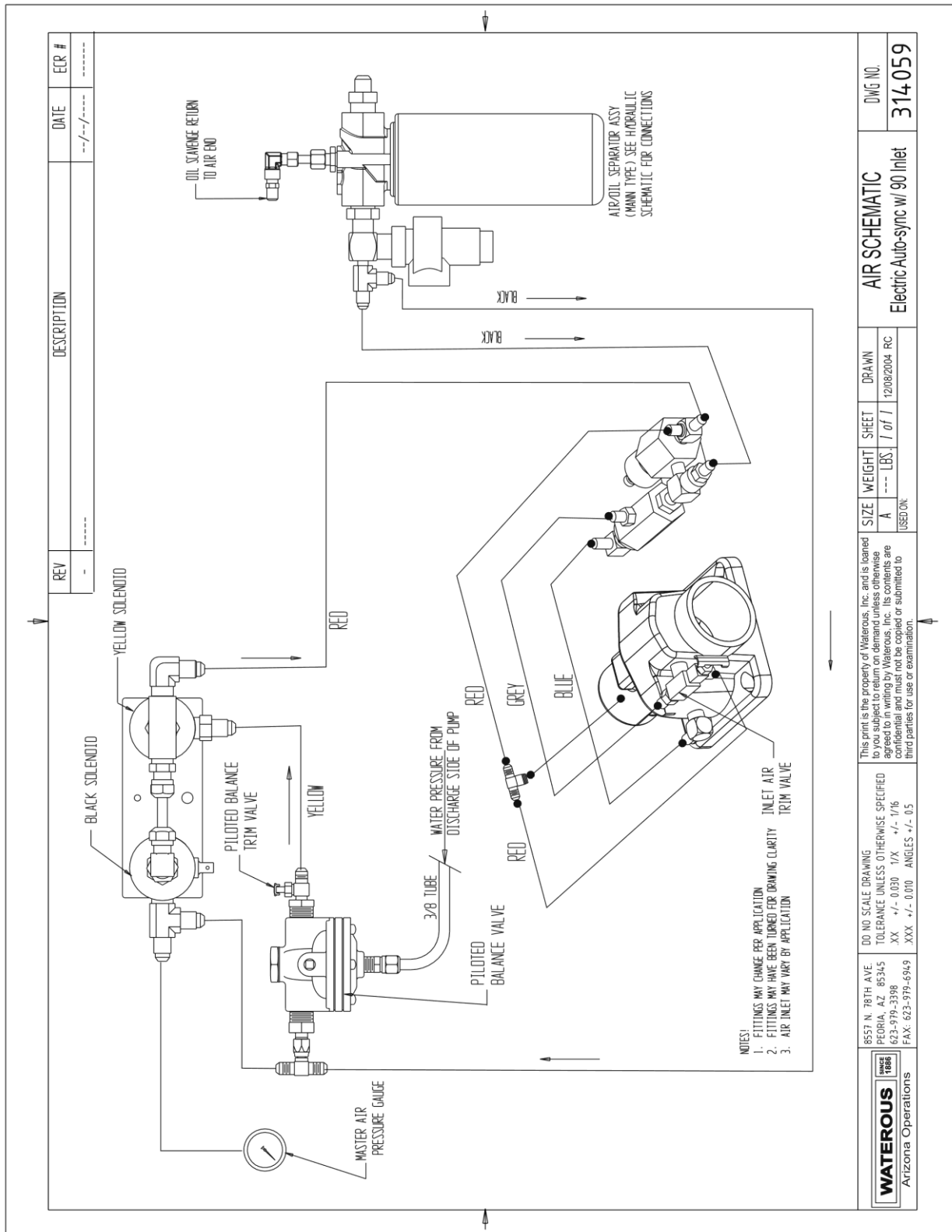

Figure 12 Air Schematic, Electric Auto-sync, 90° Inlet

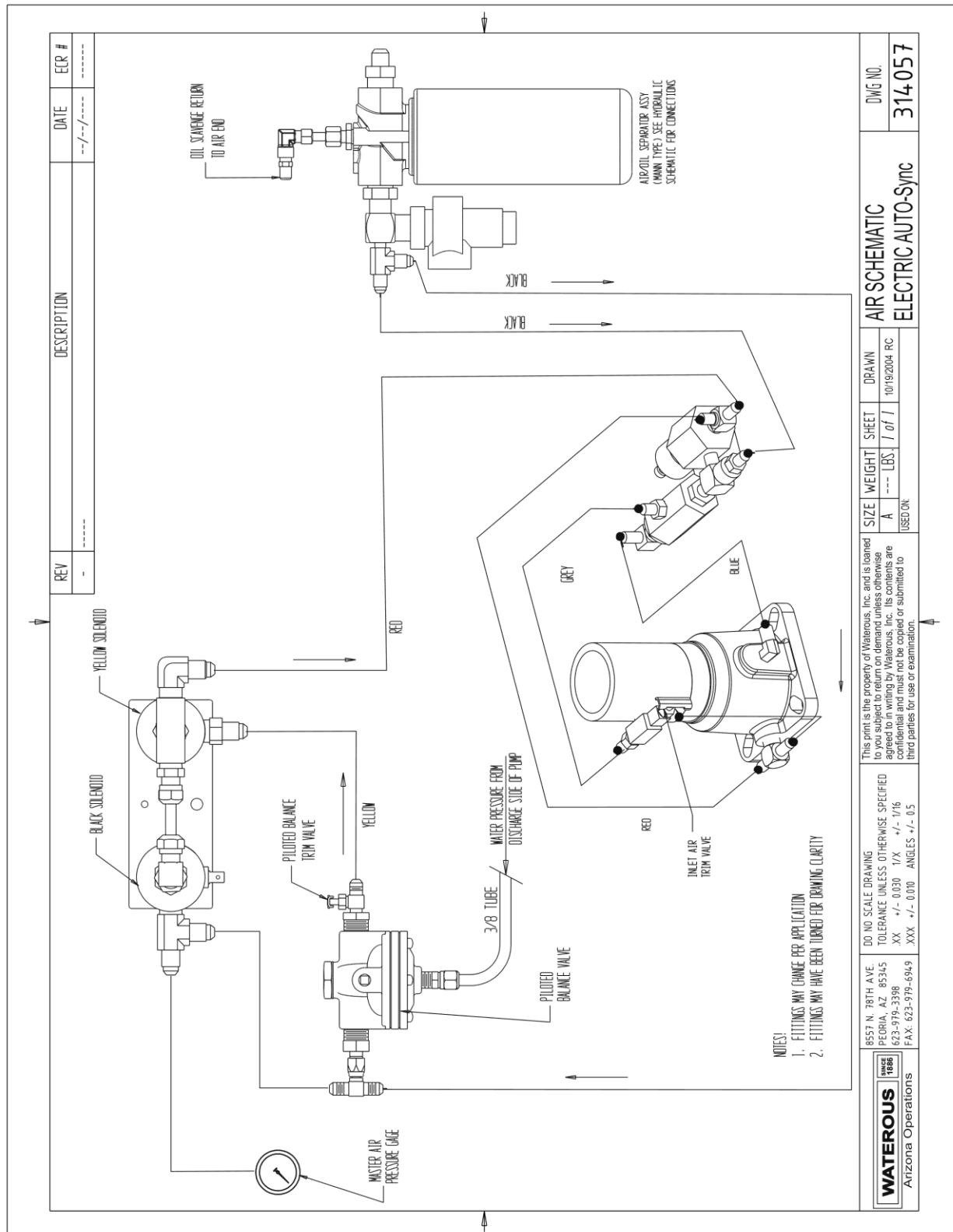

Figure 13 Air Schematic, Electric Auto-sync, Vertical Inlet

## SECTION 8. CONDITIONAL 5-YEAR WARRANTY POLICY

WATEROUS warrants, to the original Buyer only, that products and parts manufactured by WATEROUS will be free from defects in material and workmanship under normal use and service for a period of five (5) years from the date the product is first placed in service, or five and one-half (5-1/2) years from the date of shipment by WATEROUS, whichever period shall be the first to expire; provided the Buyer notifies WATEROUS, in writing, of the defect in said product within the warranty period, and said product is found by WATEROUS to be nonconforming with the aforesaid warranty. When required in writing by WATEROUS, defective products must be promptly returned by Buyer to WATEROUS at WATEROUS plant at Peoria, Arizona, or at such other place as may be specified by WATEROUS, with transportation and other charges prepaid. A Returned Material Authorization (RMA) is required for all products and parts and may be requested by phone, fax or mail. The aforesaid warranty excludes any responsibility or liability of WATEROUS for:

- a) damages or defects due to accident, abuse, misuse, abnormal operating conditions, negligence, accidental causes, or improper maintenance, or attributable to written specifications or instructions furnished by Buyer;
- b) defects in products manufactured by others and furnished by WATEROUS hereunder, it being understood and agreed by the parties that the only warranty provided for such products shall be the warranty provided by the manufacturer thereof which, if assignable, WATEROUS will assign to Buyer, if requested by Buyer;
- c) any product or part, altered, modified, serviced or repaired other than by WATEROUS, without its prior written consent; and
- d) the cost of dismantling, removing, transporting, storing, or insuring the defective product or part and the cost of reinstallation.
- e) normal wear items (including, but not limited to belts, hoses, check valves, packing, strainers, filters, light bulbs, anodes, intake screens, mechanical seals, etc.).

This warranty is subject to WATEROUS Conditions of Sale (detailed on WATEROUS Invoice) as currently in effect all of which are herein incorporated and by this reference made a part hereof

All other warranties are excluded, whether express or implied by operation **of law or otherwise, including all implied warranties of merchantability or fitness for purpose. WATEROUS shall not be liable for consequential or incidental damages directly or indirectly arising or resulting from the breach of any of the terms of this limited warranty or from the sale, handling, or used of any WATEROUS product or part. WATEROUS liability hereunder, either for breach of warranty or for negligence, is expressly limited at WATEROUS option:**

- a) to the replacement at the agreed point of delivery of any product or part, which upon inspection by WATEROUS or its duly authorized representative, is found not to conform to the limited warranty set forth above, or
- b) to the repair of such product or part, or
- c) to the refund or crediting to buyer of the net sales price of the defective product or part. Buyers remedies contained herein are exclusive of any other remedy otherwise available to Buyer.

Waterous, Arizona Operations  
7612 North 74th Ave.  
Glendale, Arizona 85303  
www.waterousco.com



Compressed Air Foam Systems